

TOWER LIGHT 多層式信號燈

SPECIFICATION 規格

TOWER LIGHT 信號燈	LEVEL 層數	VOLTAGE 電壓	FILAMENT BULB 鎢絲燈泡	LED BULB LED燈泡	BUZZER 蜂鳴器	dB 分貝
LTM	1-5	DC: 12, 24 AC: 12, 24, 110, 220, 240	✓			
LTGM	1-5		✓			
LTM-D	1-5		✓	✓		
LTM-DF	1-4		✓	✓	✓	93
LTGM-D	1-5		✓	✓		
LTGM-DF	1-4		✓	✓	✓	93

FEATURES :

- Domes for the assorted colors: available in red, yellow, green, blue and white lens.
- Grey color wire = buzzer
- Easy to change loose a screw change the lens or bulbs.
- Only installing one tower light: it can show the different signals for the production flow of machine.
- Have two indications: by the styles of steady or flashing.
- Also can steady with buzzer or flashing with buzzer.
- With elegant design: can be clearly seen the efficiency from any directions.
- Two select switch.

*Buzzer A mode: Flashing with buzzer.
B mode: Steady with buzzer.

*No buzzer A mode: Flashing
B mode: Steady

特徵：

- 燈罩顏色有紅、黃、綠、藍、白五種美麗，鮮豔的顏色
- 蜂鳴器的連接線為灰色
- 只要卸下上蓋一支固定螺絲，即可自行變顏色
- 只要安裝一台即能掌握各種機械之不同操作信號
- 可獨立定光或閃光來標示
- 具有蜂鳴器的功能
- 外形精美別緻，可自任何方向明顯確認
- 備有選擇開關模式

- * 備有蜂鳴器的信號燈 模式A: 閃光及閃爍蜂鳴器模式
模式B: 定光及不閃爍蜂鳴器模式
- * 沒有蜂鳴器的信號燈 模式A: 閃光模式
模式B: 定光模式

LED BULB 燈泡顏色	LED BULB WATT LED燈泡瓦特			
	VOLTAGE 電壓			
	12VDC/VAC	24VDC/VAC	110VAC	220/240VAC
RED 紅色	±0.9W	±0.8W	±1.6W	±3.6W
GREEN 綠色	±0.9W	±0.8W	±1.6W	±3.6W
BLUE 藍色	±0.9W	±0.8W	±1.6W	±3.6W
WHITE 白色	±0.9W	±0.8W	±1.6W	±3.6W

LTM/LTGM WIRING DIAGRAM 配線圖 Flashing Or Steady Mode 閃光或定光模式

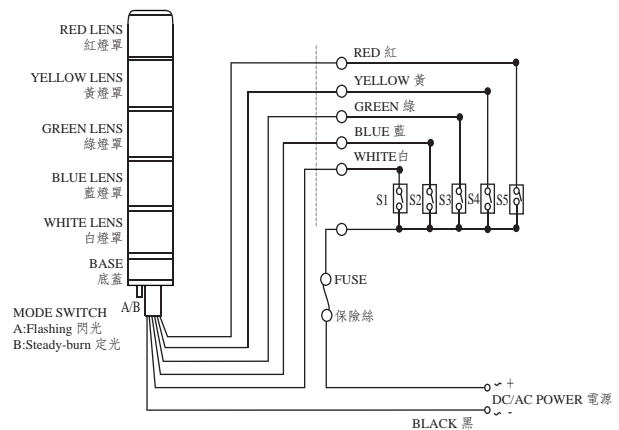

LTM

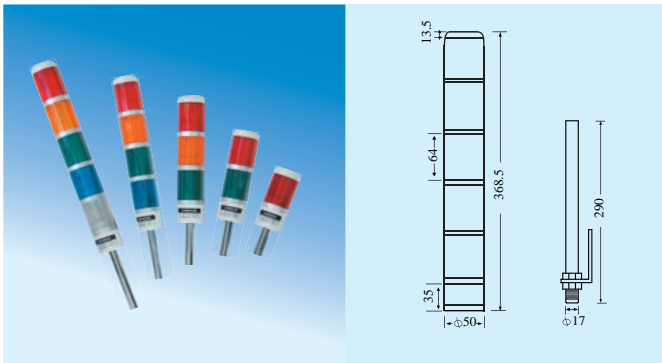

LTGM

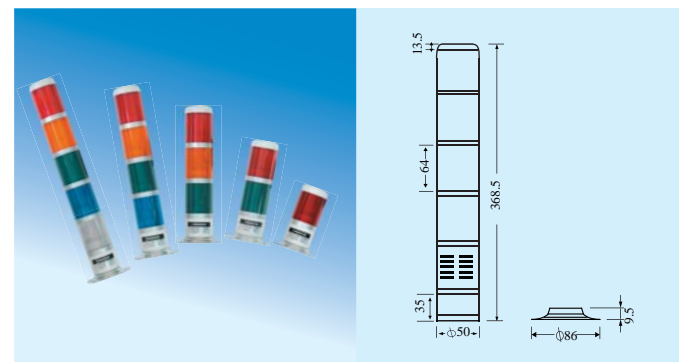

LTM-D

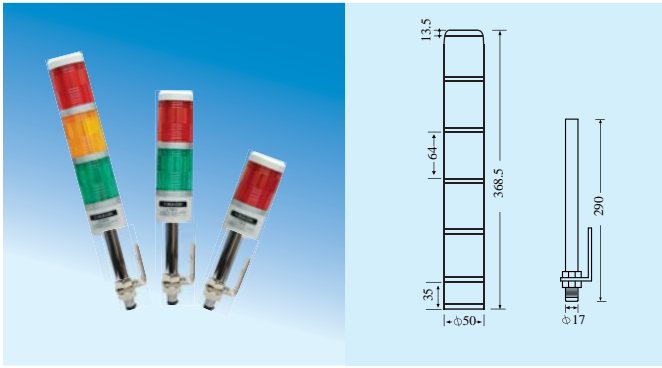

LTGM-D

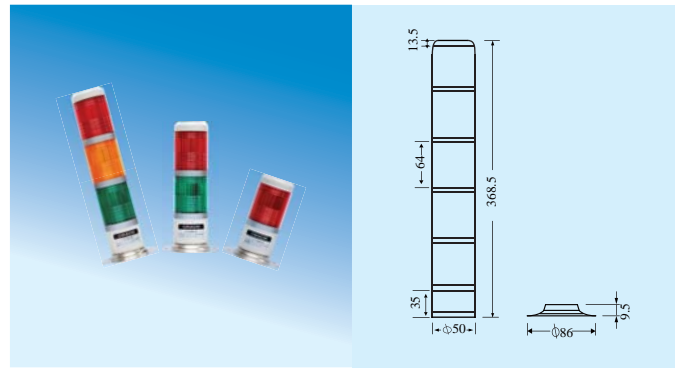

LTM-DF

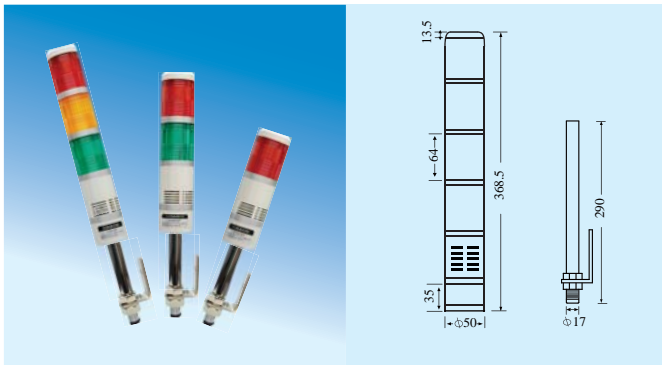

LTGM-DF

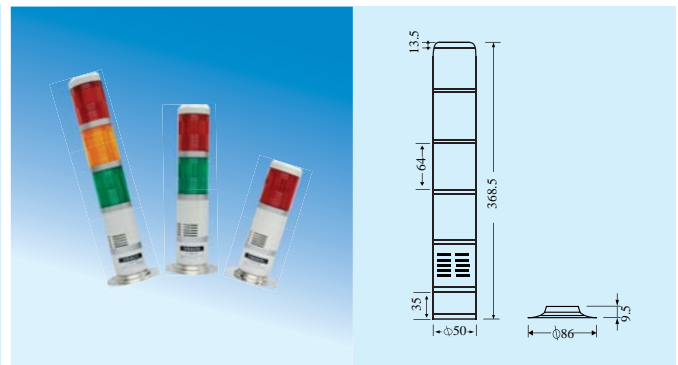

Remarks: > LTM-D/LTGM-D/LTM-DF/LTGM-DF, ignore brown color wire in steady mode.

> F = Buzzer

附注 :> LTM-D/LTGM-D/LTM-DF/LTGM-DF, 在選用定光模式下, 棕色電源線可以不使用。

> F = 蜂鳴器

LTM-D/LTGM-D WIRING DIAGRAM 配線圖

Flashing Or Steady Mode 閃光或定光模式

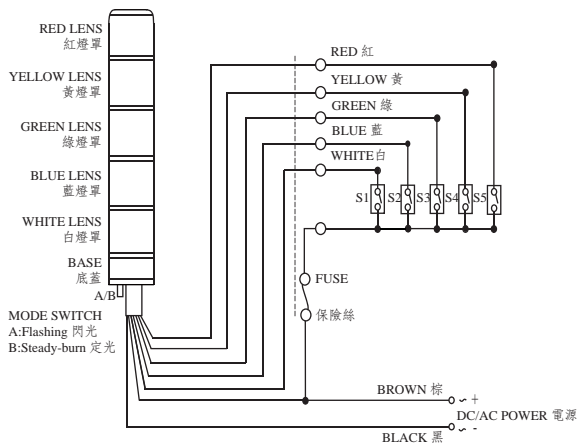

LTM-DF/LTGM-DF WIRING DIAGRAM 配線圖

Flashing, Steady or Buzzer Mode 閃光, 定光或蜂鳴器模式

